

- ALUMINUM FACE, PAINTED STEEL OPPOSED BLADE DAMPER
- ADJUSTABLE CURVED BLADES
- MINIMUM SIZE = 6 X 6
- MAXIMUM SIZE = 14 X 14
- FINISH: WHITE (W) ENAMEL

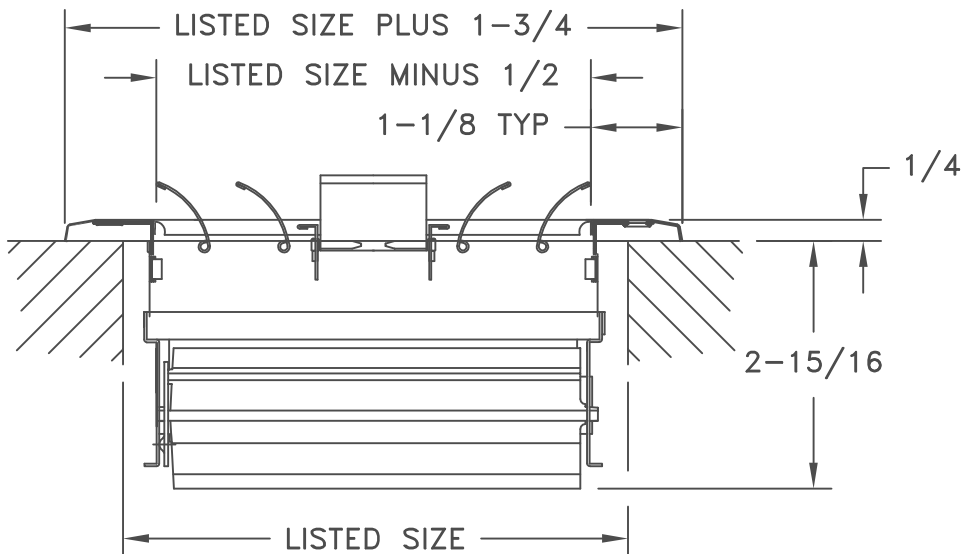
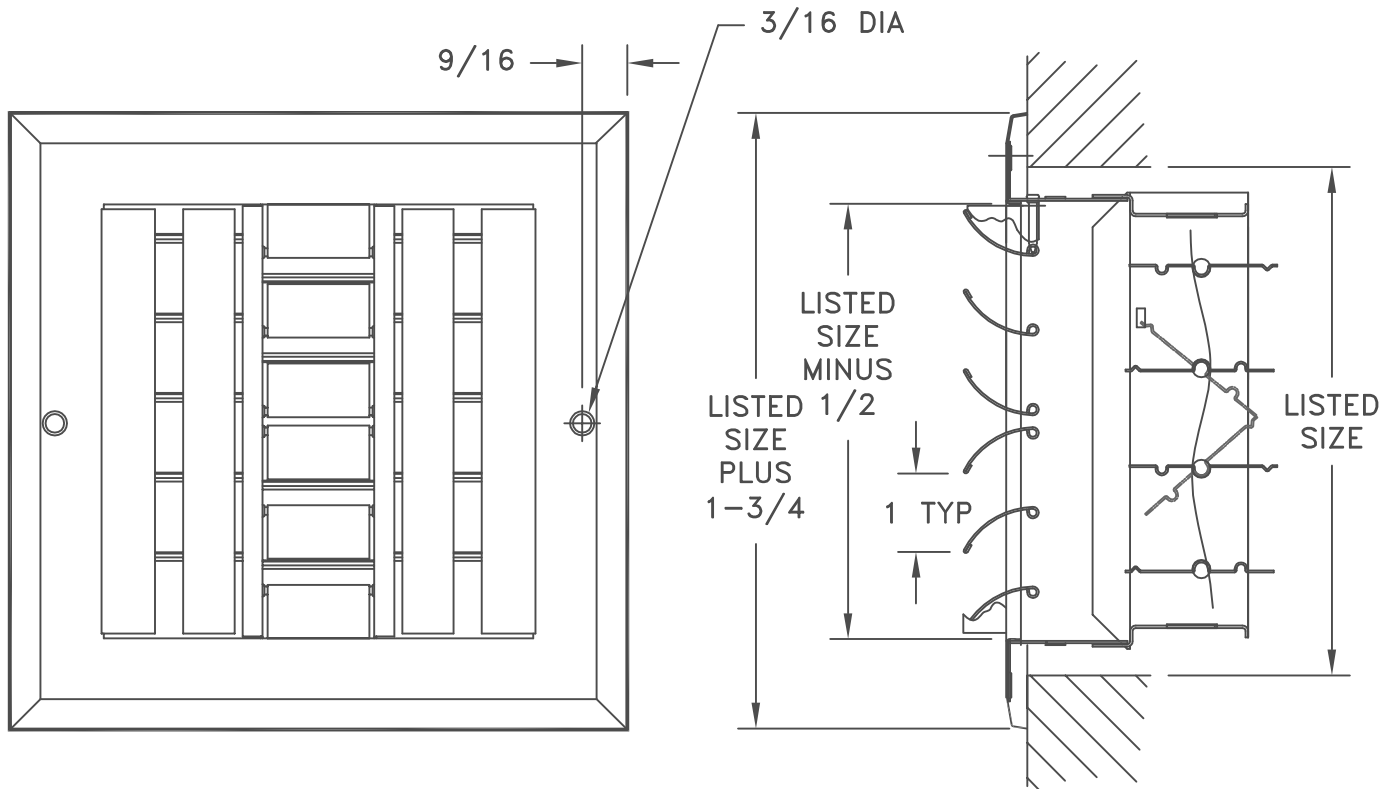

JOB NAME: _____	SUBMITTED BY: _____	DATE: 07/20/2014	SD-2509
LOCATION: _____		A484-OB	
ARCHITECT: _____		Aluminum, Curved Blade Register	
ENGINEER: _____		With Painted Steel	
CONTRACTOR: _____		Opposed Blade Damper	
		4-Way Air Pattern	